

# Electric Woodchip-Burning Stationary Rack BBQ Smoker

## OWNER'S MANUAL 230 VAC / 50 Hz UNITS



**SC-200  
Smoke Chef**



# **CONGRATULATIONS!**

**In selecting Southern Pride, you have chosen the finest, most advanced and most fully automatic woodchip burning barbecue smoker available. With us, “It’s Simply, a Matter of Pride”.**

**Please read this Manual carefully prior to installation, operation and maintenance of your Southern Pride smoker. Proper installation, operation, and maintenance are essential for your satisfaction and safe operation.**

## **KEEP THIS MANUAL FOR REFERENCE**

**NOTE: An Electrical Diagram for this appliance can be found on the inside of the service access panel.**

# TABLE OF CONTENTS

Safety Information and Precautions.....	5
Diagram of Controls & Components.....	6-7

## INSTALLATION

Receiving the Smoker.....	8
Delivery Location.....	8
Unloading the Smoker.....	8
Unpacking the Smoker.....	8
Site Instructions .....	8
Electrical Instructions.....	9
Installation Instructions for Restraining Device .....	10
Venting Instructions.....	11

## OPERATION

Woodchip Box Loading Instructions .....	12
Product Loading Instructions .....	13
Control Operating Instructions.....	13-14
Product Unloading Instructions.....	14
Ash Removal Instructions.....	15
Grease Removal Instructions .....	15

## MAINTENANCE

Daily .....	16
Monthly .....	16-17
As Needed .....	18-19
Wiring Diagram.....	20
Replacement Parts List .....	21
Before You Call For Service.....	21
Limited Warranty .....	22

# SAFETY INFORMATION AND PRECAUTIONS

This Manual should be considered a permanent part of this smoker. **THE SMOKER MUST BE INSTALLED BY A QUALIFIED SERVICE TECHNICIAN.** All troubleshooting guides, component views and parts lists included in this manual are for general reference only and are intended for use by qualified technical personnel.



## DANGER:

Improper installation, alteration, adjustment, service, or maintenance could result in severe injury, death, or cause property damage. Read the installation, operating, and maintenance instructions thoroughly before installing or servicing this equipment.



## DANGER:

Do not store or use gasoline or other flammable vapors or liquids in the vicinity of this or any other appliances.



## WARNING:

### ELECTRIC SHOCK HAZARD

Follow these rules to avoid electric shock.

- Use only a properly grounded circuit.
- Do not spray water directly on electrical components.
- Turn off power before servicing.
- Read the owner's manual before using.



## CAUTION:

Metal parts and surfaces of this smoker become extremely hot when in operation. To avoid burns, always use hand protection when operating the smoker.

1. **IT IS EXTREMELY IMPORTANT TO FOLLOW THE PRESCRIBED CLEANING INSTRUCTIONS. GREASE OR SOLIDS BUILDUP INSIDE THE SMOKER COULD RESULT IN A FIRE HAZARD.**
2. This smoker is intended for use in commercial facilities where all operators are familiar with the purpose, limitations, and associated hazards of this equipment. The operating instructions and warnings must be read and understood by all operators and users.
3. This manual and all supplied instructions, diagrams, schematics, parts lists, notices and labels must remain with the smoker even if the smoker is sold or moved to another location.
4. The area around the smoker **MUST** be kept clear and free of combustible materials, gasoline and other flammable vapors and liquids.
5. The flow of combustion and ventilating air **MUST NOT** be obstructed from reaching the smoker.
6. The frame of the smoker **MUST** be electrically grounded at all times. See "Electrical instructions".
7. **DO NOT** remove service compartment access panels when smoker is in operation or leave off during operation.
8. **DO NOT** allow unqualified personnel to perform service work or adjustments on this smoker. Doing so, will **VOID WARRANTY** and could result in a hazardous condition.
9. Ensure new employees, who might operate the smoker, are properly instructed and supervised on the operation and safety information prior to operating the smoker.
10. Ashes removed from the woodchip boxes should be stored in a non-combustible container with a sealed lid only. Store ashes in a well ventilated area. **FUMES COULD BE HAZARDOUS.**

# DIAGRAM OF CONTROLS AND COMPONENTS

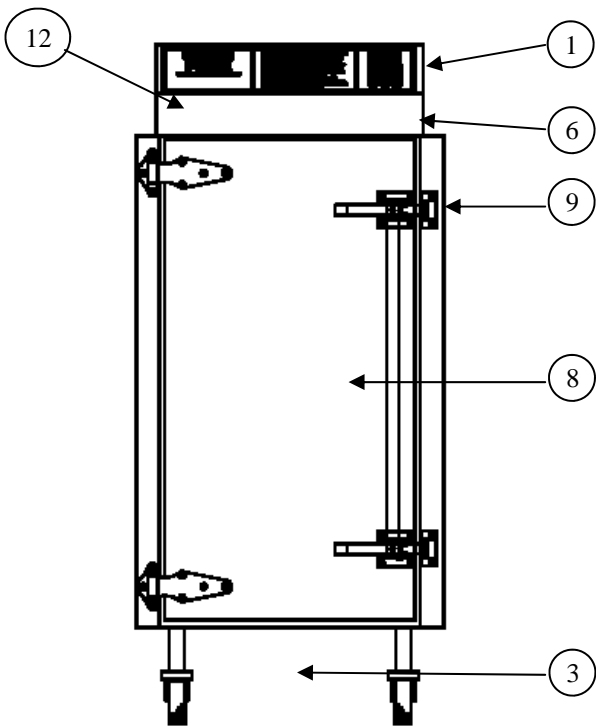

Front View

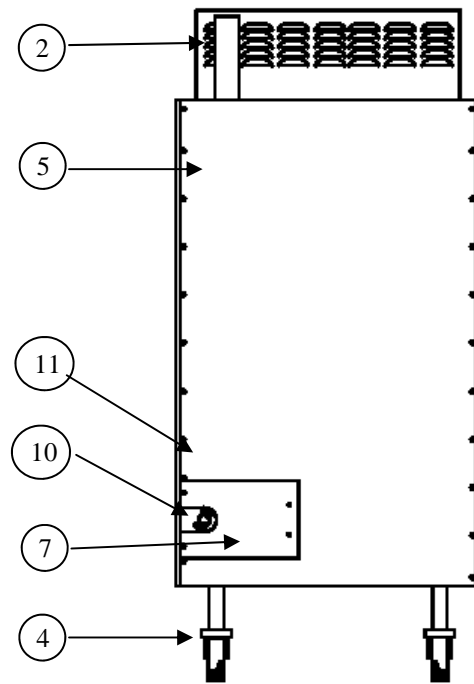

Rear View

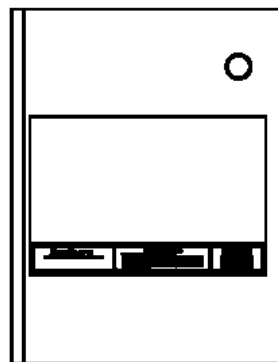

Top View

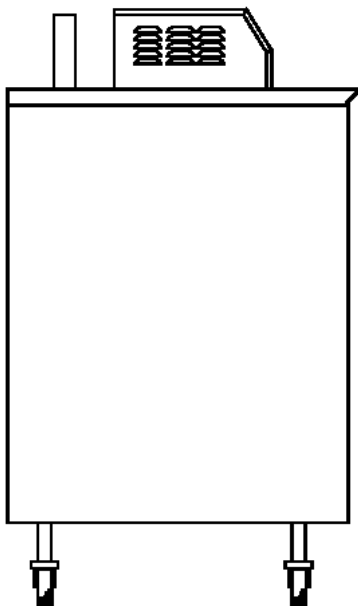

Left Side View

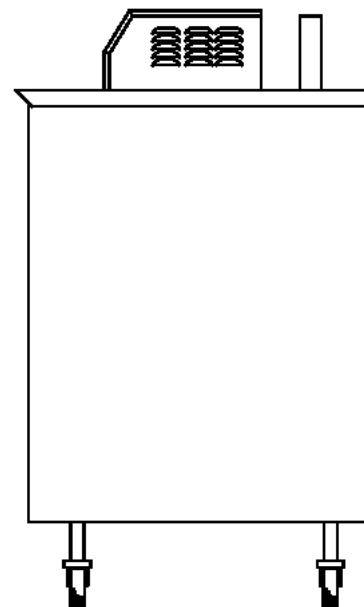

Right Side View

# DIAGRAM OF CONTROL AND COMPONENTS

1. **DIGITAL COOK & HOLD CONTROL** - Provides precise temperature control of the smoker along with control of the other functions of the smoker.
2. **FLUE** - Smoker vents through the flue while cooking. Flue outlet should be positioned under a canopy hood.
3. **GREASE DRAIN PAN** – Opening in bottom of smoker allows grease to drain from Smoker into pan during the cook cycle. **Pan must be emptied after each cook cycle.**
4. **CASTER WHEELS** - Casters provide a solid base and offers convenient mobility. The front casters are locking.
5. **DATA PLATE** - Label containing smoker's serial number, model number, manufactured date, etc.
6. **CONTROL / FAN MOTOR COMPARTMENT** – Location of the convection fan motor, control module and relay board.
7. **ELECTRICAL COMPARTMENT COVER** - Access to the terminal block for electrical connection.
8. **PRODUCT LOADING DOOR** – Provides access to load/unload product and for cleaning the interior of the smoker.
9. **PRODUCT LOADING DOOR LATCHES** - Latches apply positive pressure and seals door.
10. **POWER CORD CONNECTION** - Access point for supply power cord to smoker.
11. **TETHER / WALL ANCHOR BOLT MOUNTING LOCATION** - Threaded hole for installation of eyelet bolt used to attach restraining device for smokers mounted on caster wheels to guard against transmission of strain to the electrical connections.
12. **EMERGENCY STOP SWITCH** - Shuts incoming power off to the smoker.

# INSTALLATION

## RECEIVING THE SMOKER

Once the smoker arrives you will need a forklift to unload the crated smoker from the truck, or utilize lift gate delivery service.

Model	Approx. Wt. Uncrated	Approx. Wt. Crated
SC-200	129 kg	227 kg

**NOTE:** The above weights are for the base model only.

## DELIVERY LOCATION

Commercial smokers are large and heavy. Before scheduling the delivery of your smoker have a plan and location in place to accept the delivery of the smoker and maneuver the smoker into the desired installation location. The trucker will require a flat, level surface that is safe from traffic to unload the smoker. A forklift will be required to unload the smoker unless lift gate delivery has been specified. The trucker is only responsible for delivery of the smoker. It is your responsibility to unpack the smoker, move it to its installation location, and install the smoker.

## UNLOADING THE SMOKER

Once the smoker has been unloaded from the truck, note any damage to the crate, smoker or accessories. **Do not sign the delivery bill until the smoker has been inspected and any damage noted on the delivery bill.**

The smoker is shipped on a wooden pallet with oriented strand board (OSB) sides and top. Once the smoker is in a level and safe place remove the top and sides. The piece of OSB on the side of the box folds down and functions as a ramp. After folding down the ramp and unlocking the casters the smoker can be slowly and carefully rolled off the pallet. To prevent the smoker from tipping over, two people should guide the smoker down the ramp.

## UNPACKING THE SMOKER

The cardboard box beside the smoker on the pallet contains the following items:

- (2) 18" x 26" (457 x 660mm) nickel chrome product racks (3 product racks are located in the smoker).
- 2 1/2" (63.5mm) grease drain pan
- (2) woodchip boxes
- Restraining device
- (2) Drop-in flue dampers

## SITE INSTRUCTIONS

The Southern Pride smoker must be installed in a location that will permit the smoker to function for its intended purpose and to allow adequate clearance for ventilation, proper cleaning, and maintenance access.



# INSTALLATION

## ELECTRICAL INSTRUCTIONS

### Electrical Requirements:

- 230 volts AC, 50 Hz
- 2 wire with ground
- 30 amp required



### WARNING:

This appliance, when installed, must be electrically grounded in accordance with local codes.

**THE WARRANTY IS VOID IF THE SMOKER IS CONNECTED TO ANY VOLTAGE OTHER THAN SPECIFIED ABOVE AND ON THE SMOKER DATA PLATE. THE CHASSIS MUST BE GROUNDED TO PREVENT POSSIBLE SHOCK HAZARD.**

**Remove all packing material before connecting the electrical supply to the smoker.**

1. The smoker is not equipped with a power cord from the factory.
2. Power supply connections should be made with flexible conduit. Use a No. 12 AWG wire suitable for at least 90° C.
3. The power is to be left OFF throughout the installation.
4. Electrical service is provided to the smoker at the main terminal block located behind the access panel in the lower rear left corner of the smoker
5. Verify correct voltage at the main terminal block and replace the access panel.
6. The restraining device must be installed.

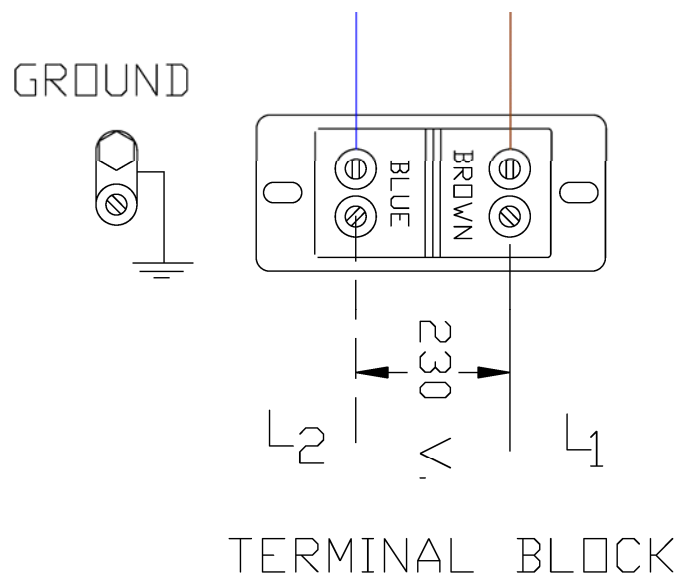

# INSTALLATION INSTRUCTIONS FOR RESTRAINING DEVICE

1. Restraining device should be installed parallel (in line) with the power supply cord.
2. Restraining device parts list: See Figure A for a photo of the materials contained in the restraining kit.
3. Attach staple bracket: Fasten the staple bracket (Figure B) to a stud located in the wall that the power receptacle is located on. Use the (4) #10 x 1" screws and plastic anchors if needed.
4. Install eyebolt: Thread jam nut onto eyebolt. Screw eyebolt into threaded hole above the power cord connection point on back of smoker. Tighten eyebolt and then tighten jam nut to keep eyebolt tight (Figure C).
5. Connect restraining cable: Attach one end of cable using the spring loaded hook to the eyebolt. Attach other end of cable to the staple bracket using the other spring loaded hook.
6. Note: To provide strain relief the restraining cable must be shorter than the power supply cord. The restraining device should always be connected when the smoker is in use.



**Figure A**

1. Staple bracket
2. Eyebolt with jam nut
3. Restraining cable
4. Spring loaded hook
5. #10 x 1" screws
6. Plastic anchors
7. Instruction sheet



**Figure B**



**Figure C**

# VENTING INSTRUCTIONS

**THE METHOD OF VENTILATION MUST BE APPROVED BY THE LOCAL CODE ENFORCEMENT AGENCY PRIOR TO EQUIPMENT INSTALLATION.**

1. The smoker ventilation system should comply with this manual.
2. It is recommended that Local Code Officials and a Commercial Kitchen Ventilation Contractor be consulted prior to installation.

## CANOPY HOOD VENT

All smoker models may be installed under an approved canopy hood system rated for commercial cooking appliances.

- Placement under a common hood shared with other appliances may be prohibited.
- Southern Pride recommends a minimum canopy overhang of 6 inches (152mm) on all sides.
- Exhaust fan size must be determined by a ventilation contractor specifically for your application. Hood dimensions, exhaust duct length and routing all factor into the calculation.

## VARIABLE SIZED DROP-IN FLUE DAMPER

The smoker is equipped with a 2" (51mm) flue outlet on the top of the smoker. To increase the flexibility of the smokers, each smoker comes with two (2) drop-in flue dampers to adjust the size of the flue outlet. The options are:

- A. No drop-in flue damper – A fully open 2" (51mm) flue outlet.
- B. Drop-in flue damper with center piece removed – A 1 - 5/16" (33mm) flue outlet.
- C. Drop-in flue damper without center piece removed – A 3/4" (19mm) flue outlet.

To remove the drop-in flue damper center piece, use a screwdriver to pry the piece loose and remove it from the rest of the drop-in flue damper.

NOTE: A restricted flue will maintain more moisture and smoke in the smoker cabinet.



A.



B.



C.

# OPERATION

The smoker should be operated in the following order (with all operations according to the subsequent instructions):

1. Load the woodchip boxes with the desired woodchips.
2. Load the product into the smoker and close the product loading door.
3. Ensure that the drain pan is empty and installed in the pan rails located under the smoker drain hole.
4. Set the control and start the cook cycle.
5. Once the cook cycle is complete, turn the control off.
6. Remove the product from the smoker.
7. Remove the ashes from the woodchip boxes.
8. Empty the grease from the grease pan.

## WOODCHIP BOX LOADING INSTRUCTIONS

1. Ensure the control is OFF, or in the Idle or Pause position, before opening the product door.
2. Slide each woodchip box off of the smoke element bracket.
3. Load woodchips into each woodchip box. **THE WOODCHIPS ARE ONLY USED TO FLAVOR THE PRODUCT, NOT TO HEAT THE SMOKER.**
4. Close the woodchip box lid and slide the boxes onto the smoke element brackets.
5. If the cook menu was paused, a press of the start button is required to resume the menu..



### WARNING

**Woodchip boxes must be installed on the smoke element brackets at all times during operation of the smoker. Failure to do so can damage the smoke elements and/or result in terminal failure of the smoker.**



### CAUTION

- **Remove coals and ashes from previous cook cycle before loading new woodchips into the woodchip box. Refer to Ash Removal Instructions on page 15.**
- **Woodchip box will be hot when the smoker has been in operation.**
- **Do not overload woodchip box.**

# PRODUCT LOADING INSTRUCTIONS

The smoker is equipped with five (5), 18" x 26" (457 x 660mm) product racks for the loading of product.

1. Remove the wire product rack from the smoker.
2. Place the product directly on the product rack, leaving an air gap between each piece of product.
3. With the product placed on the product rack, carefully slide the loaded product rack into the smoker starting from the bottom rack slide position.
4. Repeat steps 2 and 3 until all product is loaded into the smoker. Product height will determine how many rack slide spaces you need to maintain an air gap between each loaded product rack.

# CONTROL OPERATING INSTRUCTIONS

1. The product loading doors must be closed.
2. The control should be in the "IDLE" mode. (The elements, and convection fan will be off). If the control is "OFF" a press of any button will bring the control back to "IDLE."
3. A menu consists of a cook temperature, cook time, hold temperature, and the ability to turn the smoke elements on or off.
4. Press the cook temp button (tEnP will appear in the LED display), then press the up/down buttons to obtain the desired cook temperature.
5. Press the cook time button (tinE1 will appear in the LED display), then press the up/down buttons to obtain the desired cook time.
6. Press the hold temp button (HtEnp will appear in the LED display), press the up/down buttons to obtain the desired hold temp, if a hold temp is not desired press the down button until "OFF" is displayed in the LED.
7. Programming the menu is complete. To start the menu, press the start/stop button one time. CHIPS will appear in the LED display. Press the up button to start the menu with the smoke elements on, or press the down button to start the menu with the smoke elements off.
8. To cancel or stop the menu, press and hold the start/stop button until "IDLE" is displayed in the LED.
9. When the cook cycle is complete there are two possible actions that can be taken. One is if a hold temperature was programmed into the menu, the control will momentarily sound an audible alarm then, "HOLD" and the length of time the control has been in the hold mode will alternately flash in the LED display. The control will maintain the hold temperature until the start/stop button is depressed to "END" the menu, and bring the control to the "IDLE" mode.
10. If the hold temperature was programmed to "OFF" and the cook time has elapsed, "END" will be displayed on the LED display, and an audible alarm will sound continuously until the start/stop button is depressed, to "END" the menu, and bring the control to the "IDLE" mode.
11. After the control has been in the "IDLE" mode for five minutes it will go to "OFF", a press of any button will bring the control back to "IDLE".
12. After each cook cycle the ashes should be removed from the woodchip boxes, and the grease emptied from the drain pan.

# CONTROL OPERATING INSTRUCTIONS (continued)

## OPTIONAL MEAT PROBE

When equipped with the optional meat probe the smoker can be programmed one of two ways:

- Timed cook - Cook to a set smoker temperature using time to control the length of the cook cycle.
- Internal temperature of product cook - Cook with a set smoker temperature until the internal temperature of the product reaches the temperature the meat probe is set for.

To choose to cook by time, the control must be set to “P-off”.

1. With the control in “IDLE,” press the up button and the display will read either “P-on” or “P-off.” One press of the up button will change the setting. Change the setting to “P-off.”
2. After a three second pause the control will return to “IDLE” and the menu can be programmed. Refer to the instructions on the previous page to program a menu.

To choose to cook to an internal temperature using the meat probe, the control must be set to “P-on.”

1. With the control in “IDLE,” press the up button and the display will read either “P-on” or “P-off.” One press of the up button will change the setting. Change the setting to “P-on.”
2. After a three second pause the control will return to “IDLE” and the menu can be programmed. Refer to the instructions on the previous page to program a menu.
3. When step 5 is reached the temperature that the meat probe will cook the product to will be set instead of the cook time.
4. **NOTE:** The meat probe must be plugged into the socket inside the smoker with the probe inserted into the product. The tip of the probe should be inserted into the thicker part of the product and not against a bone.

## PRODUCT UNLOADING INSTRUCTIONS

1. Before unloading the product, the control should be in the “OFF” or “IDLE” position.
2. Carefully open the product loading door just enough to release the smoke from the cabinet, then wait approximately 5 seconds before fully opening the product loading door.
3. Product should be removed from top rack to the bottom rack.

## ASH REMOVAL INSTRUCTIONS

1. After each cook cycle, remove the remaining wood, ash and hot coals from woodchip boxes. Use heat resistant gloves while handling woodchip boxes, ash container, and ash removal tools.
2. Place small lots of them in a noncombustible corrosion resistant pan and spray with water. A noncombustible corrosion resistant pan should be kept just outside the smoker for this purpose.
3. Once wood and ash have been sprayed, place them in a heavy metal container with a tight fitting metal lid (16 gauge minimum, capacity not to exceed 20 gallon (88 liters)). This container shall be assigned for this one purpose, shall be able to be handled easily by any employee assigned the task, and shall pass easily through any passageway to the outside of the building. The container shall always be covered when it is being moved through the premises. When any hole occurs in a container from corrosion or damage, the container shall be repaired or replaced immediately.
4. The ashes should be carried to a separate heavy metal container (or dumpster), outside the premises, that is used exclusively for the purpose of hot ash storage.



### WARNING

Never empty ash/coals from the smoker into a common trash dumpster. Embers from ash/coals could ignite materials resulting in a fire.



### CAUTION

Be sure smoker product loading door is secured in the closed position immediately following a cook cycle and during non-use periods.

## GREASE REMOVAL INSTRUCTIONS



### WARNING

Do not remove the drain pan while the smoker is still in operation or while burning wood and hot coals are still in the woodchip boxes.

1. Immediately empty the grease pan after each cook cycle. **CAUTION: Grease will be hot.**
2. Grease should be poured into an approved grease recycling bin.

# MAINTENANCE



## WARNING

It is extremely important to follow the below maintenance procedures. Grease or solids buildup inside the smoker could result in a fire hazard.



## WARNING:

Before any service is performed on the smoker, the power must be disconnected and the smoker should be allowed to cool down.

## DAILY:

1. Remove all product racks from smoker and take to sink area for cleaning. Use a commercial foodservice detergent / degreaser. Follow the product manufacturer's instructions for proper use, cautions and warnings. Protective gear such as goggles and rubber gloves should be used.
2. Sanitize product racks with a commercial product service sanitizer. Follow the product manufacturer's instructions for proper use, cautions and warnings. Protective gear such as goggles and rubber gloves should be used.
3. Remove ashes and coals from woodchip boxes after each cook cycle. Refer to the Ash Removal Instructions on page 15 of this manual.
4. Drain the grease pan after each cook cycle. Refer to the Grease Removal Instructions on page 15 of this manual.

## MONTHLY:

1. Check the thermostat thermocouple. The thermocouple is located in the top, back, right inside corner of the smoker. Be sure there is no solids or creosote buildup. Clean as needed.

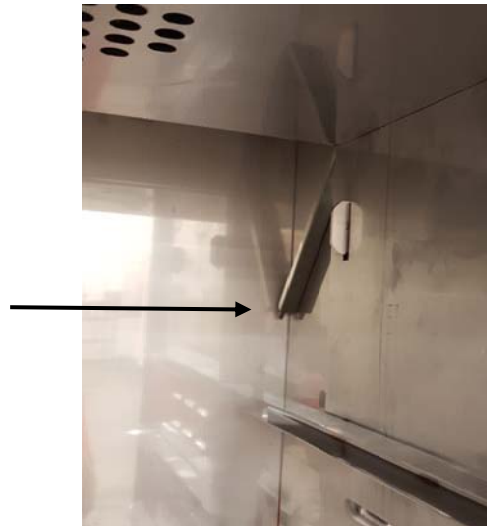

2. Check the product door hinges and the product door latches. Tighten screws and align as needed.



# MAINTENANCE (continued)

## MONTHLY (continued):

3. Remove and clean the air channels. Remove the air channels on both sides of the smoker by lifting slightly up and out. When re-installing the air channels, the bottom of the air channel should be set on the bottom catch and then leaned up and over the top slotted catches.
4. Inspect the blower wheel for solids or creosote buildup or an out-of-balance condition. Clean as needed.  
**WARNING: Solids buildup will cause the blower wheel to be out of balance and, if not cleaned, can cause damage to the blower wheel and to the convection fan motor.**

**WARNING: Smoker MUST be off with power turned off at the breaker, and allowed to cool down, before removing fan shroud.**

To remove the blower wheel for cleaning:

- a. Remove the air channels on both sides of the smoker.
- b. Remove two, 1/4-20 bolts with a 7/16 head that secure the blower wheel shroud to the smoker.
- c. Carefully allow the shroud to drop down away from the blower wheel and then pull the cover straight out of the smoker.
- d. Loosen the Allen head or square head set screw for the blower wheel.

To re-install repeat the above steps in reverse order. Be sure to tighten the blower wheel set screw.

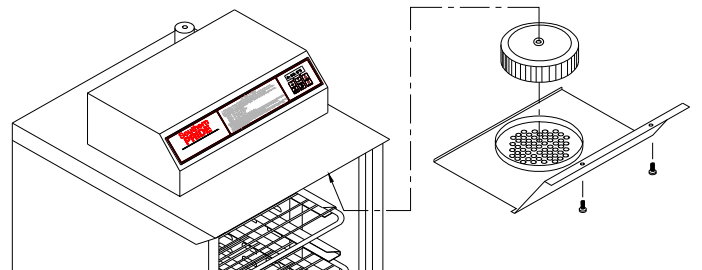

## MAINTENANCE (continued)

### AS NEEDED:

(Frequency will depend on usage and local health department's requirements):



#### WARNING

**It is extremely important to follow the below maintenance procedures. Grease or solids buildup inside the smoker could result in a fire hazard.**

### INTERIOR:

- Use a commercial product service detergent/degreaser to clean the smoker interior. Follow the product manufacturer's instructions for proper use, cautions and warnings. Protective gear such as goggles and rubber gloves should be used. **Note: Avoid the use of abrasive cleaning compounds, chloride based cleaners, or cleaners containing quaternary salts. Never use hydrochloric acid (muriatic acid) on stainless steel.**
- Smoker should be cool. Do not try to put cleaner on smoker when hot.
- While product racks are out of the smoker apply cleaner to the smoker interior: walls, ceiling, and floor and allow to soak for 10 minutes.
- Thoroughly rinse smoker interior with water using a water hose or pressure washer. **(Do not directly pressure wash the convection blower wheel; the blower wheel should be removed for cleaning).**
- Drain waste water; place a container under the drain. Dispose of rinse water according to local environmental requirements.
- Inspect the interior of the smoker for any areas that did not come clean; repeat the cleaning procedure in those areas.
- Thoroughly rinse the interior of the smoker and drain.
- Sanitize the smoker interior: walls, ceiling, floor, and convection fan with a commercial product service sanitizer. Follow the product manufacturer's instructions for proper use, cautions and warnings. Protective gear such as goggles and rubber gloves should be used. Wet all surfaces using a cloth or sprayer. Allow to remain wet for 10 minutes.
- To dry interior of the smoker leave product door open and allow to air dry.

**Note: Consult with the appropriate state or local health department regarding all applicable cleaning and sanitation requirements for equipment.**

## MAINTENANCE (continued)

### AS NEEDED:

(Frequency will depend on usage and local health department's requirements):

### STAINLESS STEEL SURFACES:

Use non-abrasive cleaning products for use on stainless steel surfaces. Cleaning agents must be chloride-free compounds and must not contain quaternary salts. Never use hydrochloric acid (muriatic acid) on stainless steel surfaces. Always use the proper cleaning agent at the manufacturer's recommended strength.

### EXTERIOR:

Southern Pride BBQ Smokers are known for their attractive appearance. We achieve this by selecting only the finest grade of type 304 stainless steel and applying exacting workmanship.

- All of the exterior of the smoker can be cleaned with a mild soap and water solution.
- Before cleaning the smoker, make sure it is turned off, and power is turned off to the smoker at the electrical panel.
- If the smoker is HOT from use, allow adequate time for it to cool down (approximately 1 hour).
- After the smoker exterior has been washed, apply a stainless steel polish cleaner to all surfaces.
- Wipe control panel, door handles, and door gaskets thoroughly, since these areas harbor food debris.
- **Do not use scotch bright pads or scouring pads to clean the outside of your smoker. If a non-abrasive scouring pad must be used, make certain to scrub with the visible grain of the surface metal to avoid scratches.**



#### CAUTION

Some cleaning products are not suitable for stainless steel; be sure to read the label before use.

# WIRING DIAGRAM

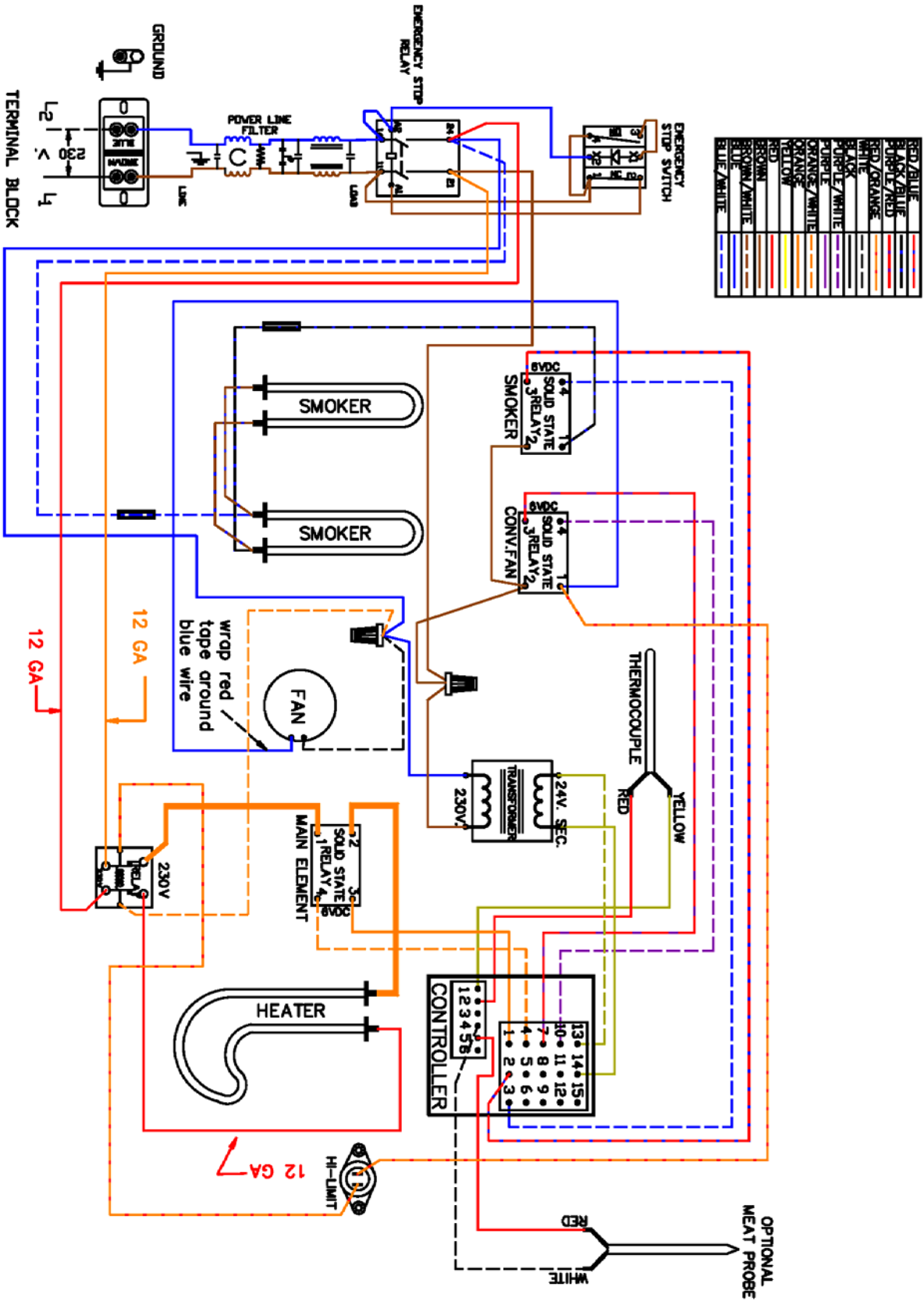

# REPLACEMENT PARTS LIST

	SC-200
<b>Gaskets</b>	
Product door	070024
Main element	073025
Smoke Element	073012
Double smoker element bracket	073038
<b>Electrical</b>	
Digital control w/o meat probe	431040
Digital control w/ meat probe	431041
230v main heating element	436028
230v smoker element	436027
Type "K" 1' thermocouple	435011
Meat probe	435018
<b>Convection</b>	
Fan motor	521009
Blower wheel	531002
<b>Door Hinges/Closers</b>	
Product door hinge	870003
Door latch and catch	871013
Door latch tie bar	247607
<b>Product Racks/Hangers</b>	
Nickel chrome product rack	970002
Stainless steel product rack	971001
<b>Miscellaneous</b>	
Variable sized drop-in flue damper	296007
2 1/2" drain pan	912003
Woodchip box	295010

## BEFORE YOU CALL FOR SERVICE



### WARNING:

Before any service is performed on the smoker, make sure it is turned off, and power is turned off to the smoker at the electrical panel.

SYMPTOM	WHAT TO DO
Smoker does not start	<ul style="list-style-type: none"> <li>• Check that the menu is programmed and the Start/Stop button has been pressed.</li> </ul>
Noise inside the smoker	<ul style="list-style-type: none"> <li>• Check and clean the convection blower wheel.</li> <li>• Verify that the fan shroud and air channels are properly seated.</li> </ul>
Error 10 appears on the control	<ul style="list-style-type: none"> <li>• Plug the meat probe into the probe receptacle, or turn the meat probe off by pressing the up arrow.</li> </ul>

# LIMITED WARRANTY

Southern Pride Distributing, LLC (“Southern Pride”) warrants to the original purchaser that any original part found to be defective in material or workmanship will, at Southern Pride’s option, subject to provisions hereinafter stated, be replaced with a new or rebuilt part. The labor warranty, provided only in the U.S.A., remains in effect one (1) year from installation or fifteen (15) months from the shipping date, whichever occurs first. Southern Pride will bear normal labor charges performed by an authorized Southern Pride service agent during standard business hours, and excluding overtime, holiday rates or any additional fees. The parts warranty remains in effect for one (1) year from installation or fifteen (15) months from the shipping date, whichever occurs first. All warranty parts ship via standard ground delivery service.

This warranty does not cover the following:

- Improper installation, delivery or maintenance.
- Failure of the Product if it is abused, misused, or used for other than intended purpose.
- Products which are not defective or broken, or which are working as described in the Owner’s Manual.
- Damage to the Product caused by accident, fire, floods, or acts of God.
- Damage caused by services performed by unauthorized service companies.
- Service calls to correct the installation of your Product or to instruct you how to use your Product.
- Expenses for making the Product accessible for servicing.
- Replacement of consumable parts; belts, gaskets, light bulbs, etc.

## NO IMPLIED WARRANTY, REPRESENTATION OR CONDITION

To the extent permitted by law, neither Southern Pride nor any company/individual affiliated with it makes any warranties, representations, conditions or promises express or implied as to the quality, performance or freedom from defect of the smokers covered by these warranties other than those set forth above, and **NO STATUTORY OR IMPLIED WARRANTIES OR CONDITIONS OF MERCHANTABILITY OR APPLICABLE PERIOD OF WARRANTY SET FORTH ON THIS PAGE. THE PURCHASER’S ONLY REMEDIES IN CONNECTION WITH THE BREACH OR PERFORMANCE OF ANY WARRANTY ON THE PRODUCTS ARE THOSE SET FORTH ON THIS PAGE. IN NO EVENT WILL SOUTHERN PRIDE OR ANY COMPANY/INDIVIDUAL AFFILIATED WITH IT BE LIABLE FOR INCIDENTAL OR CONSEQUENTIAL DAMAGES.** In no event shall Southern Pride be liable for loss of use, loss of revenue or profit, or loss of product, or for any indirect, incidental or consequential damages.

## LIMITATION OF LIABILITY

Southern Pride will not be liable under any circumstances for any incidental, consequential or special damages, including without limitation any lost profits or labor costs, arising from the sale, use or installation of the products, from the products being incorporated into or becoming a component of another product or from any other cause whatsoever, whether based on warranty (expressed or implied) or otherwise based on contract, on tort or any other theory of liability, and regardless of any advice or representations not in writing that may have been rendered by Southern Pride concerning the sale, use or installation of the products. In the event the above warranty fails to correct purchaser’s performance problems caused by defects in workmanship and/or materials, purchaser’s exclusive remedy shall be limited to payment by Southern Pride of actual damages in an amount not to exceed the amount paid for the smoker

## IF YOU NEED SERVICE

To secure warranty service, the purchaser must (1) report the equipment defect to their authorized Southern Pride distributor and request warranty service within the applicable warranty term; (2) present evidence of the warranty start date with a valid proof of purchase; and (3) make the Product available within a reasonable time.

Should your problem not be solved to your complete satisfaction by your authorized Southern Pride distributor, you should contact Southern Pride at PO Box 354, Alamo, TN 38001, Phone: 1-800-437-2679. When contacting the manufacturer, the following information will be requested: (a) Model and serial number of the Product, (b) Address where the Product is installed, (c) Name and address of the installer and any service agency that performed service on the Product, (d) Date of original installation and dates any service work was performed, (e) Details of the problems as you can best describe them, (f) List of people, with dates, who have been contacted regarding your problem.